

# AlphaVision<sup>®</sup> ML

safety & security



***User manual***

## TABLE OF CONTENTS

<b>Table of contents</b> .....	<b>2</b>
<b>Introduction</b> .....	<b>4</b>
Purpose of this manual .....	4
General Guidelines .....	4
European norm and security Grade .....	5
Zones and sections of the AlphaVision ML control panel .....	5
<b>OPERATION</b> .....	<b>8</b>
Function of the navigator keys when programming .....	8
Meaning of the LED's of the keypad .....	9
Arming/Disarming with user codes .....	10
Access control using a level 1 proximity tag .....	10
Arming with a level 2 user code .....	11
Arming and disarming with a level 3 user code .....	11
Arming and disarming with a level 4 user code .....	11
Arming and disarming with a level 5 or 7 user code .....	11
Incorrect or incomplete code .....	11
Arming and disarming with a proximity tag .....	11
Total arming .....	12
Partial arming .....	12
Disarming .....	12
Switching from Partial to Total arming .....	12
Stop exit delay when disarming .....	12
Entry/Exit mode .....	12
Quick arming .....	12
Bypassing .....	13
Screensaver .....	13
Alarm in a 24 hour zone .....	13
Panic alarm .....	13
Trigger output .....	14
Internal buzzer .....	14
Trouble buzzer .....	14
Information Present .....	14
LCD/Proximity keypad .....	14
Arming and disarming with a tag on an LCD/Proximity keypad .....	14
Proximity Reader .....	15
Arming and disarming with a tag on an external proximity reader .....	15
Access control with a proximity tag on an external proximity reader .....	15
Arming and disarming with wireless keyfob transmitters .....	16
<b>USER MENU</b> .....	<b>16</b>
Date and Time .....	18
Time switch .....	18
Users .....	19
Valid days .....	20
Sections .....	20
User name .....	21
Enrolling proximity tags on an LCD/Proximity keypad .....	21
Warning against double or conflicting user codes .....	21
Duress code .....	21
Security against random entering codes .....	21
Telephone .....	21
Speech & Sounds .....	22
Open zones .....	23

Maintenance .....	23
Walktest zones .....	24
Test LED & LCD .....	24
IP connection .....	24
Remote Service .....	24
Installer access .....	25
Transmit testmessage .....	25
Access via App.....	25
App key.....	25
Bypassing zones .....	25
Historic Log.....	25
Acceptance mode .....	26
Speech/Listen-in option .....	26
Inactivity.....	27
Remote control of the AlphaVision ML.....	27
Single ring-in.....	27
Double ring-in .....	27
<b>IP REPORTING.....</b>	<b>28</b>
<b>PSTN PLUG-ON OPTION .....</b>	<b>28</b>
<b>GSM PLUG-ON OPTION .....</b>	<b>28</b>
<b>GPRS PLUG-ON OPTION .....</b>	<b>28</b>
<b>APPENDIX A: DETECTOR DEPLOYMENT (ASK INSTALLATION COMPANY TO COMPLETE) .....</b>	<b>29</b>
<b>APPENDIX B: KEYFOB TRANSMITTER ASSIGNMENT .....</b>	<b>30</b>
<b>APPENDIX C: SOCIAL ALARM TRANSMITTER .....</b>	<b>30</b>
<b>APPENDIX D: PROGRAMMED PRIVATE TELEPHONE NUMBERS .....</b>	<b>31</b>

## INTRODUCTION

### Purpose of this manual

The purpose of this manual is to introduce the user to the AlphaVision ML burglary alarm system. The manual explains about controlling and dealing with the control panel. Several of the special options explained in this manual can only be executed by the main user.

By taking into account several guidelines, your system will function properly for a very long time:

Never panic when the alarm sounds. Simply disarm the system with your PIN code, proximity tag or wireless keyfob transmitter and view the information shown on the LCD display.

The control panel is equipped with a keypad with LCD display, section LED's and status LED's. THE LCD and LED's provide information about the system's status. If the information on the display is not clear, consult your user manual first.

Never give your PIN-code, proximity tag or keyfob transmitter to another user, this might lead to unpleasant situations.

In case of a malfunction, first consult your user manual. When the malfunction persists, then immediately contact your installation company. The installation company will give you further instructions.

Write down important events (false alarm, user errors, etc.) in a logbook, together with the zone number, date and time. Your installation company might be able to take additional steps to prevent the situation from occurring in the future.

The AlphaVision ML control panel has been designed and is tested according to all current regulations on stability, reliability and insensitivity from external electrical influences.

### General Guidelines

The AlphaVision ML control panel can be used for detecting and reporting burglary, fire, hold up, tamper and social alarms. The control panel can be armed and disarmed using a PIN-code or with Proximity tag. If your AlphaVision ML has been equipped with the optional wireless receiver, up to eight wireless keyfob transmitters can be used for arming and disarming. The LCD or LCD/Proximity keypad has numerical keys and navigator keys. The navigator keys are used to arm and disarm the system and to navigate through the programming menu's. The various status LED's and the integrated LCD display give the user information on the system status.

The heart of your security system is a sophisticated electronic device placed in a metal casing, which has been professionally installed by your installer. This device is called the "**control panel**". On this control panel the detectors, the sirens and flashlights, the telephone line and the power line is connected.

A **detector** is also known as a "sensor". A detector is a device that is designed to detect a certain phenomenon. There are for instance, detectors that detect smoke. When such a detector detects smoke, it will report this to the control panel. There are also detectors that detect motion. When these detectors 'see' motion, they will report this to the control panel. For windows and doors, usually magnetic contacts are used. These magnetic contacts are used to signal whether a door or window is open or closed.

When the control panel receives an alarm, it will take further actions. This can be for instance triggering the alarm sirens or flashlights or initiate a call to a central station or private (mobile) telephone number. The detectors are connected to the "inputs" of the control panel, so that the control panel knows which detector triggered an alarm. These "inputs" are also called "zones".

## European norm and security Grade

The Alpha Vision ML, the I/O module and associated components comply with the following European standards:

<b>EMC emission:</b>	EN301489-3 2002
<b>EMC Immunity:</b>	EN50130-4 2003
<b>Radio:</b>	EN300220-3
<b>Telephony:</b>	TBR21 1998
<b>Safety class:</b>	European standard EN60950
<b>Security grade:</b>	European standard EN50131-3 (2009), EN50131-1 (2006) and A1 (2009) as "grade 2 - low to medium risk" and "environmental class II - Indoor general"

## Zones and sections of the AlphaVision ML control panel

The AlphaVision ML control panel has 12 wired inputs and can be expanded to up to a maximum of 100 wired zones. Also 32 wireless zones can be used, these replace hardware zones. Each zone is programmed into the control panel and provides information about a certain event in a certain area of the house or building.

The AlphaVision ML control can control up to 4 **sections**. Sections are also known as 'Groups' or 'Areas'. A section contains one or more zones and is used to arm and disarm a specific part of the house or building. The sections are displayed as digits 1 to 4 on the left hand side of the keypad. The section LED's 1 to 4 are only visible once the section is armed.

The 8 sections (areas) of the AlphaVision ML can be armed and disarmed independently from each other or simultaneously depending on the arming method and user level. Arming and disarming is done using a PIN-code, a proximity tag or a keyfob transmitter. Which and how sections are armed/disarmed depends on the way the system is armed/disarmed and the user level that is programmed to the PIN code or proximity tag. The keypad has 4 navigator keys (the 4 keys on the right). The navigator keys can be used for two direct arming methods: a Total arming and a Partial arming. When the user is at home, part of the system can be armed (Partial, for example sections 1 and 2). In this way the premises can be secured, while the users can walk freely inside the premises. When the user leaves the home or building, the system can be armed totally (for example sections 1, 2, 3 and 4) by simply pressing the Total key. An extra 'quick arming' option can be programmed by your installer to be able to arm the system Partial or Total without having to enter a PIN-code. For disarming, a PIN-code or presenting a proximity tag is always required. The installer will program which sections and thus corresponding zones are active during Partial and Total arming.

**User Codes:** you can program up to 90 users codes (more than one code can be programmed as supervisor code), the use of a duress code is optional. In addition there is one installer code. Users have the choice of a PIN-code or a proximity tag (optional). The total of both is 90. Assuming six-digit PIN codes are 999999 valid codes. PIN 000000 is invalid. If the duress code option is used, there are 499999 valid codes. The code of a proximity pass is automatically translated into a 6-digit PIN-code. From software V2.0 and above it is possible to program all PIN codes as 4-digit, a fundamental choice must be made to between all PIN-codes as 4-digit or 6-digit.

**Mobile application:** a mobile application (APP) is available to arm and disarm the alarm system using a smartphone. Ask your installer for the availability and capabilities of the mobile application.

►! *The use of a mobile application (APP) is not permitted in certified installations.*

Both to the left and to the right side of the LCD display, status LED's can be found.

LED's 1 to 8 on the left side of the display indicate which sections are armed or disarmed. When all LED's are off, the system is disarmed. When one or more LED's are on, those specific sections are armed. Not all situations will require 8 separate sections. When the system is armed Partial or Total with the navigator keys, this is also shown by the status LED's on the right side of the LCD display. The meaning of all the status LED's is explained further in this manual.

Example of an installation with sections:

An installation in a house has 8 zones. Zones 1 to 6 are used for detectors on the first floor and are programmed to section 1. Zones 7 and 8 are used on the second floor and are programmed to section 2. When the users leave the house, both sections are armed so that all detectors are active. When the users go to bed, they can use Partial arming for arming section 1. In this case only zones 1 to 6 on the first floor are active and the users can walk freely on the second floor, without activating the alarm.

When the installer programs the detectors, he will assign a "zone type" to each zone, depending on which detector is used and at what location it has been installed. The following zone types can be programmed:

A **direct** zone has no entry or exit delay and will, if the system is armed, cause an alarm as soon as the detector is triggered.

A **delayed** zone has an entry and exit delay. The delay times can be programmed as desired. When the system is armed and a delayed zone is triggered, the entry delay will start. During the entry delay time, the system must be disarmed or an alarm will follow. The same occurs during the exit delay. When you arm the system, the exit delay starts. Depending on the programming your installer has done, delayed zones must be closed before arming the system. In some cases delayed zones may be open during arming, for instance the front door can be open during arming.

A **follower zone** will respond as a direct or as a delayed zone, depending on whether the control panel's entry or exit delay is triggered or not. When the entry delay time is triggered, a follower zone will function like a delayed zone (thus not causing a direct alarm when triggered). When the entry delay is not triggered, the zone will function like a direct zone and cause an alarm as soon the zone is triggered. Your installer can inform you which zones are programmed as follower zones.

A **Follower delayed zone** is equal to the regular follower zone, with the exception that the follower delayed zone always functions as a delayed zone when the system is Partial armed. The system **must be armed with the Partial key**. The installer will program the appropriate sections.

An **Emergency Door zone** is a zone type used for emergency doors. An emergency door zone is a 24-hour loud zone type but will only activate the alarm outputs when the system is disarmed. When the system is armed, this zone type will activate the alarm outputs and also report the alarm to the monitoring station.

A **24-hour zone** is always triggered, regardless if the control panel is armed or not. This zone type can be used for glass break detectors or emergency push buttons. The AlphaVision ML control panel has a 24H silent and a 24H loud zone type. Only with the 24H loud zone type the siren and flashlight will be activated. In both cases an alarm will be reported directly to the monitoring station or to the programmed private telephone number.

A **fire zone** is also a 24-hour type zone and is used for smoke and fire detectors. When the fire zone is triggered, the control panel will sound an intermitting alarm sound, known as a slow-whoop sound.

A **social alarm zone** is a 24-hour silent zone and can be used with emergency pushbuttons for social alarm purposes. When required, the user can be notified that the emergency pushbutton was pressed by a speech text. For this, an optional speech board and speaker is required.

A **hold-up zone** is also a 24-hour silent zone and can be used for hold-up push buttons. The alarm will be reported to the monitoring station or private telephone, but no further indications on the display or outputs will be shown or heard.

A **tamper zone** is also a 24-hour zone and is used in tamper situations, e.g. when a detector cover is opened or a siren or flashlight is tampered with.

A **technical alarm zone** is also a 24-hour silent zone and can be used to report technical malfunctions, e.g. a malfunction of the central heating system, etc.

A **gas alarm zone** is also a 24-hour loud zone and is used for reporting alarms from carbon monoxide or other gas detectors.

A **water alarm zone** is a 24-hour loud zone used for reporting alarms from water detectors. Water detectors are commonly used in cellars and near washing machines.

A **temperature alarm zone** is a 24-hour loud zone used for reporting alarms from temperature sensors. These sensors are used to detect and signal too high or too low temperatures.

A **direct dialer input** is used to report alarm messages directly to a monitoring station or private telephone. When this type of input is activated, the alarm outputs will not be activated and nothing will be displayed on the keypad. When the input restores, a separate restore-message will be sent.

A **keyswitch input** is used in situations when an external keyswitch or device is used to arm and disarm the system. A keyswitch or external device can only be used for Total arming and disarming.

## OPERATION

The AlphaVision ML control panel is supplied with an LCD or LCD/Proximity keypad. Both types of keypad have an LCD display, section LED's, status LED's and silicon keys. The keys are divided in numerical and navigator keys (the 4 right most keys). The numerical keys are mainly used for arming/disarming with a PIN-code.

The navigator keys are used for easy Partial arming, Total arming, disarming and for navigating through the user menu.

When using an LCD keypad, the AlphaVision ML is armed and disarmed with a 6-digit PIN code. The LCD/Proximity keypad has an integrated proximity reader for arming/disarming with a coded tag, known as a proximity tag. The integrated proximity is located right above the microphone hole, at the bottom center of the keypad.

When the AlphaVision ML control panel is expanded with a wireless receiver module, the system can also be armed and disarmed with wireless keyfob transmitters.









The keypads have an LCD display, section LED's and status LED's. The LCD display is used to display messages from the control panel. Next to the LCD display there are status LED's, each with their own meaning. Both the LCD display and the silicon keys have a backlight which can be programmed to 'always on' or 'turn off after 20 seconds'.

Besides optical indications the keypad has an integrated buzzer which is used for audible signaling of the entry and exit delays and for error indications.

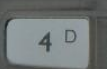
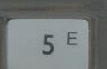

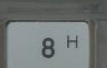
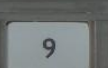

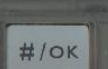
When the AlphaVision ML is expanded with a speech plug-on board, alarm and alert messages can be reported as speech messages to a (mobile) telephone. One of the LCD or LCD/Proximity keypad can also be expanded with integrated speakers and microphone. This keypad can be used for vocal assistance.

### Navigator keys

The 4 navigator keys on the right hand side are used for Partial and Total arming, disarming and for navigating through the user menu.

	Operating:	Navigating:
	= Partial arming (Partial)	= left
		
		
	= Show information	= up/previous menu item
		
		
		
	= Disarm	= down/next menu item
		
		
		
	= Total arming (Total)	= right
		

### Function of the navigator keys when programming

When programming, the four keys on the right of the keypad have different meanings. To enter the programming menu, use the <#/OK> key. The four keys on the right are now used for going Left , Up , Down  and Right .



### Meaning of the LED's of the keypad

In idle state the top line of the display shows the House Identity (default ALPHAVISION ML). Your installer can program the system to show the family name or company name. The second line displays the date (European style Day-Month-Year) and time (Hours:Minutes).

The keypad has two rows of LED's, placed on the left and right sides of the display and keys. On the left side, eight LED's 1 to 8 show the status of the eight sections (Illuminated when armed).

 = Section 1

 = Section 2

 = Section 3

 = Section 4

 = Section 5

 = Section 6

 = Section 7

 = Section 8

On the right side, several status LED's are placed. These LED's indicate the following:

 = Total armed

 = Partial armed

 = Disarmed

 = IP dialer transmitting

 = GSM/GPRS dialer transmitting

 = PSTN dialer transmitting

 = OK (all zones closed)

 = Power (230V)

 = Unread information available

The green **OK** LED is used for indicating that all zones are closed and that the system is ready to be armed. Each keypad can be linked to specific sections or areas of the building. The OK LED will only show the status of the zones programmed in this section(s). When any of the zones in the section are open, the green OK LED will be off. In this case the system cannot be armed; when trying to arm the system will display "open zones" in the display. Before arming, close these open zones first.

The green Power / **230V** LED gives the following indications:

When the Power LED is on, the 230V power line is connected and available. When the LED flashes, the power is cut off; this will also be displayed with the "Information Present" message.

The various dialer LED's (IP, GSM/GPRS or PSTN) are only on when the corresponding dialer is busy sending a message from the buffer. When the dialer failed to deliver the message to the monitoring station or private telephone, the dialer will automatically stop (after the programmed number of dial-attempts has passed) and the dialer LED will start flashing. The next time the dialer has a message to send, the LED will turn on again. When the message can be delivered this time, the LED will turn off.

When the system is disarmed with a **DURESS** code, the dialer LED's will be disabled automatically for 15 minutes. Also the "Information Present" message will not be shown on the display and the trouble buzzer will be disabled. **DURESS** codes are only used for disarming under threat and transmit a silent alarm to the monitoring station/ telephone. For more information on Duress codes, see chapter 'Duress codes'.

### **Arming/Disarming with user codes**

By default, the AlphaVision ML is armed and disarmed from the keypad with 6-digit user codes (PIN-codes). From software V2.0 and above it is possible to program all PIN codes as 4-digit, a fundamental choice must be made to between all PIN-codes as 4-digit or 6-digit, your installer will discuss this with you during installation. There are two types of keypads available for the AlphaVision ML, the LCD keypad and the LCD/Proximity keypad. The LCD/Proximity keypad has an integrated proximity reader for arming/disarming with a coded tag, known as a proximity tag. The integrated proximity is located right above the microphone hole, at the bottom center of the keypad. Both keypads allow arming and disarming with **user codes**. For obvious reasons it is very important that this code remains **SECRET**.

Up to 90 user codes can be programmed in the AlphaVision ML (100.000 possible combinations). User number 90 is dedicated for the supervisor and can be used for both arming/disarming, entering and executing functions from the user menu and view available system information.

The proximity TAG is a different type of user code. The proximity tag contains a chip with a fixed code. When enrolling the TAG it is automatically translated into a PIN-code, thus presenting the tag to the internal reader is considered similar to entering a PIN-code.

To separate different types of authorization each user code is programmed to a specific **LEVEL**. Level 1 is the level with lowest authorization and level 7 with the highest. Level 6 does not exist in the AlphaVision ML. For more information about the user codes and the levels, please refer to the User menu / Change Codes chapter.

User code number 90 is the **supervisor** code and is set to default code: **445566**. After entering six invalid codes an alarm message is sent to the monitoring station (if programmed) and the keypad is locked for 90 seconds.

The AlphaVision ML can be armed and disarmed with a **duress** code. The duress code is used when the user is forced under threat to disarm the system and can **only** be used with PIN-codes (not with proximity keys). Duress codes can only used when reporting alarm messages to a monitoring station are not displayed on the display of the keypad. When the duress code is used, the dialer LED, Information message and trouble buzzer are not shown or heard on the keypad for 15 minutes.

### **Access control using a level 1 proximity tag**

The Alpha Vision ML panel can be expanded with an external proximity reader for outdoor access control. Users with a level 1 proximity tag can gain access to the house or building by presenting the proximity tag to the external proximity reader. A level 1 user code cannot be used to arm the system and therefore does not make sense to associate it to a PIN-code. Once the user's presents his/her proximity tag (level 1) to the external proximity reader the system will first check if the section (s) assigned to this proximity tag are disarmed. If the Section (s) are disarmed the external proximity reader will activate its internal o.c. output for 3 seconds to unlock the door. If the Section (s) are armed, the door will remain locked.

### Arming with a level 2 user code

When the control panel is in idle state and a level 2 code is entered, the display changes to:

Section: 12..

<#>=ARM

When the <#> key is pressed, sections 1 and 2 are armed. If section 1 was already armed, section 2 will now also be armed. Level 2 user codes can **only** be used for **arming**. The supervisor code (level 7) can program which section(s) can be armed.

### Arming and disarming with a level 3 user code

When the control panel is in idle state and a level 3 code is entered, the display changes to:

Section: 12..

<\*>=DIS. <#>=ARM

Level 3 users can use <\*> to disarm or <#> to arm both sections simultaneously. The supervisor (level 7) can program which section(s) can be armed and disarmed.

### Arming and disarming with a level 4 user code

Level 4 codes are **only** used for arming/disarming with a **proximity tag**. Level 4 user codes are equal to level 3 codes but do not require entering <\*> or <#>. If section 1 was already armed then it will now be disarmed. When presenting the proximity tag again both section 1 and 2 will be armed. The supervisor (level 7) can program which section(s) can be armed and disarmed.

### Arming and disarming with a level 5 or 7 user code

When the control panel is in idle state and a level 5 or 7 code is entered, the display changes to:

ARM: 1...

DIS: .2..

The display is divided in two lines. The top sections are sections which are/will be **armed**; the bottom sections are sections that are/will be **disarmed**. When key <1> is pressed, digit 1 will switch position. The same applies for the other sections shown. The sections are only armed/disarmed when the <#/OK> key is pressed to confirm.

Both level 5 and 7 user codes can separately decide which sections are armed and disarmed. The supervisor (level 7) can program which section(s) can be armed and disarmed. Aborting arming or disarming can be done by pressing the <\*> key.

### Incorrect or incomplete code

Conforms European standards the AlphaVision ML (from V2.xx) contains a security mechanism for entering an incorrect or incomplete user code. If an incorrect user code is entered ten (10) times the keypad will be locked for 90 seconds. Also entering an incomplete code, for example 3-digit and then nothing counts as incorrect user code.

After the next (2<sup>nd</sup>) cycle of ten (10) incorrect or incomplete user codes the keyboard will be locked again for 90 seconds but will also send a message (SIA code 'JA') to the central station (if applicable).

If in the meantime one (1) correct code is entered, the "wrong code" counter mechanism will be reset.

### Arming and disarming with a proximity tag

When the AlphaVision ML control panel is installed with an LCD/Proximity keypad, the system can be armed and disarmed with a proximity tag. The proximity reader is integrated in the keypad and is located right above the microphone hole, at the bottom of the keypad. Present the proximity tag approximately 2-5 cm in front of the keypad to arm or disarm the system. When the proximity tag is programmed with level 4 authorization, the system will arm or disarm immediately.

## Total arming

The AlphaVision ML control panel is normally armed by entering a valid user code and depending on the code level, by pressing <\*> or <#>. Besides this way, the AlphaVision ML can also have two quick arming keys for Total and Partial arming. Your installer can program which sections are armed with Partial and which sections are armed with Total arming. For Total arming, press the  key. If programmed, the system will now ask to enter a valid user code. When the system is Total armed, the corresponding section LED's 1 to 4 will turn on to indicate the armed state.

## Partial arming

The shortcut key for Partial arming  can be used for quick Partial arming. If programmed, the system will ask to enter a valid user code. When the system is Partial armed, the corresponding section LED's 1 to 4 will turn on to indicate the armed state.

## Disarming

The AlphaVision ML control panel can also be disarmed with a shortcut key. To disarm the system, press the  key. When disarming, the system will always ask for a valid user code. Enter a 6-digit valid user code to disarm.

## Switching from Partial to Total arming

When the AlphaVision ML is Partial armed with the shortcut key, the  key can be used to arm the system to its Total state. If programmed, the system will ask for a valid user code.

## Stop exit delay when disarming

When the AlphaVision ML has been expanded with a wireless receiver module and the system is armed with a keyfob transmitter, the AUX button can be used for Direct arming. When the AUX button on the keyfob transmitter has been programmed for "direct arming", pressing it within 5 seconds after arming will cause the exit delay to be cancelled and the system is armed immediately.

## Entry/Exit mode

From software V2.0 and higher your installer can program the AlphaVision ML to be compliant with the new EN50131 guidelines to reduce false alarms. If the programming option 'EN50131' is selected then the following functionality applies:

- If during the exit delay an instant or 24-hour zone is activated then the arming procedure is aborted. This is indicated by sounding 10 short acoustic signals via the LS (loudspeaker) output. Also, a message (SIA code NCI) is transmitted to the central station to indicate that the arming was aborted.
- If during the entry delay an instant or 24-hour zone is activated the installed sounders and strobe lights are activated immediately but the alarm will be reported to the central station at least 30 seconds later and always after the expiry of the entry delay time. If the system is disarmed before the end of the total time (at least 30 seconds and always after expiry of the entry delay) then no alarm will be transmitted to the monitoring station.

## Quick arming

The installer can program the AlphaVision ML in such a way that **no user code** is required when arming with the shortcut keys for Partial and Total arming. When programmed, the user codes are only required for disarming the system.

Bear in mind that Quick arming also comes with a risk: when no user codes are required for Total and Partial arming, everybody can arm the system, regardless of the authorization level of the users.

## Bypassing

When programmed, zones can be temporarily bypassed, or locked out. A bypassed zone means that alarms coming from this zone (detector) are ignored. This is only required in exceptional cases, for instance when a detector malfunctions or keeps on giving false alarms.

When a malfunctioning detector remains open, the control panel would normally not be able to arm. By temporarily bypassing this zone, the system can still be armed.

When the system is armed and a direct, 24-hour or some of the delayed zones are open, the display will report "CAN NOT ARM, ZONES OPEN". When the option 'Bypass' is **disabled**, the display will change to the "Open Zones" menu and show the first open zone on the display. Use the  key to view any other open zones. Close the "Open Zones" menu by pressing the <\*> key. Close the open zones (windows, doors, etc.) and try to arm the system again.

When Bypassing is **allowed**, the display will report "CAN NOT ARM, ZONES OPEN", followed by the Open Zones menu. The system will show the first open zone on the display. Use the  key to view any other open zones. After the last open zone is shown, the option "EXIT <\*>, BYPASS <#>" will be displayed. By pressing the <#/OK> key, all open zones are automatically bypassed and the system is armed. By pressing <\*>, the system will abort the arming and return to its idle state.

Bypassed zones cannot trigger the alarm. A zone is only bypassed for one armed 'session'. When the system is disarmed, the bypass is cancelled as well.

From firmware version 3.2 and above it is also possible to bypass (block) zones prior to arming the system. This can be useful if a fault occurs in a detector or unexplained false alarms occur. The new bypass function was added as a separate menu option in the user menu. For details, see chapter 'User Panel - Bypass'

## Screensaver

Your installer can determine whether the backlight of the LCD display and silicone keys on the keypad is always illuminated or automatically turned off after 20 seconds. This also applies to the status LEDs (to the left and to the right of the display). If a key is pressed it will activate the background lighting and status LEDs again. This will prevent that the status of the system is visible from outside the premises.

If the option 'off after 20 seconds' is selected and the system is enabled, then after the expiry of the 20 seconds the backlight and LEDs extinguish. Now if an alarm or fault occurs, in accordance with EU regulations no alarm or status information will be displayed directly. Only after entering a valid user code, this information will be visible.



## Alarm in a 24 hour zone

When an alarm occurs in a 24H zone, for example a fire zone, an alarm will immediately be given. Depending on the type of 24H zone the flashlight and alarm sounders will be activated. When the alarm occurred in a fire zone, the sounder will differ from a 'regular' alarm and produce an intermitting sound. To deactivate an alarm, disarm the system, even if the system was already disarmed

Disarm the system with a valid user code, proximity tag or by pressing the disarm key () of the wireless keyfob transmitter.

Wired smoke detectors need to be manually reset after an alarm. The smoke detectors can be reset by viewing the present information messages and confirming the messages with the < #OK> key. For more information on viewing and confirming alarm messages, please go to the "Information Present" chapter.

## Panic alarm

Depending on your installer's programming, a panic function can be used. When enabled in the programming, simultaneous pressing the <\*> and <#> keys on one of the keypads or, when the wireless expansion module is used, simultaneous pressing the Partial () and Total () keys on a keyfob transmitter

will activate a panic alarm. Panic alarm will result in a panic alarm message being sent to the monitoring station or to private telephone(s) and the siren being activated. To stop the siren, disarm the system.

►! *From firmware V2.0 and higher the system can only be armed after a panic alarm if the 'Information Present' menu is opened and the information is read and erased.*

### **Trigger output**

For specific purposes or applications your installer can be program a so-called 'trigger output' (from software v2.04 and higher) that can be activated by typing in a level 1 user code (PIN-code). Once the level PIN-code is entered on the keypad the message "Trigger out is activated" will appear in the LCD display. The output will now be activated for approximately 3 seconds.

### **Internal buzzer**



All keypads have an integrated buzzer for audible assistance. The buzzer can be activated or deactivated during both the entry and exit delays, only during the exit delay or only during the entry delay. The entry and exit delays are only used when there are zones programmed as delayed zones. The installer can program which keypads sound the buzzer. The buzzer is also used to alert the user to trouble messages.

### **Trouble buzzer**

The trouble buzzer is the same internal buzzer in the keypads which indicate the entry and exit delays. The trouble buzzer sounds when a trouble or malfunction is detected. The trouble buzzer can be programmed as ON, DAYTIME and OFF by the installer, where the Daytime option disables the trouble buzzer between 19.00 and 08.00 hours (nighttime).

The trouble buzzer is used to alert the user that a trouble or malfunction has been detected in the system. When a trouble occurs, the buzzer will sound every 3 seconds, for one minute. Also the message "Information Present" will be shown on the display and the 'i' LED will flash. Please read the following menu about viewing and confirming the available information with the  key.

### **Information Present**

When the red (i) LED flashes and the message "Information Present" appears on the display, an alarm or trouble has occurred. The user has to view and confirm the information by pressing the  key, followed by a level 3, 4(tag), 5 or 7 user code. When the user code is entered, the display will show the first message. When the control panel is expanded with a speech module and a speaker, the system will also provide vocal assistance. Use the  to show any other messages. When the last message has been shown, the display will show "Del. information. <OK>. Press <#/OK> to erase the message.

When a trouble has occurred, e.g. power failure, the trouble has to be solved before the message can be erased. When the trouble has not been solved, a new "Information Present" message will appear. When the trouble cannot be solved, contact your installer immediately.

►! *If the screensaver option is enabled the Information (i) LED will not shown immediately when the system is armed. Only after entering a valid user code it will be visible and via the Information menu the information can be read and erased.*

### **LCD/Proximity keypad**

When the AlphaVision ML control panel is equipped with a LCD/Proximity keypad, the system can be armed and disarmed with a coded key, known as a proximity tag. By using proximity tags, users do not have to remember their user codes. Up to 90 proximity tags can be programmed. For more information about enrolling proximity tags, please read the chapter about creating new user codes.

### **Arming and disarming with a tag on an LCD/Proximity keypad**

The system can be armed or disarmed with a proximity tag. Depending on the authorization level the system will arm or disarm directly (level 4) or requires an additional action.

## Proximity Reader

The AlphaVision ML control panel with LCD/Proximity keypad can be expanded with an external proximity reader. The external proximity reader can be mounted outside, allowing arming and disarming with a proximity key from outside the premises. The external proximity reader can also be used for a simple form of access control. Proximity keys enrolled on the LCD/Proximity keypad will automatically be recognized by the external proximity reader.

►! *When an external proximity reader is used, the system MUST have at least one LCD/Proximity keypad*

## Arming and disarming with a tag on an external proximity reader

Arming and disarming the system with a proximity tag on an external proximity reader only works with **level 4** user (tag) codes. When the tag is presented to the reader, the section(s) programmed to this tag will arm or disarm. If an electric door strike is also connected to the proximity reader the door strike will be activated for 3 seconds.

The external proximity reader has a bi-color LED, which provides information about the system when arming or disarming. The following indications can be given:

LED	Action / condition
LED lights continuously RED	Idle state
LED flashes red (approx. 3 sec.) then returns to idle state	Invalid TAG
LED flashes green (approx. 3 sec.) then returns to idle state	Armed with a valid TAG
LED turns green (approx. 3 sec.) then returns to idle state	Disarmed with a TAG
LED slowly flashes red (approx. 5 sec.) then returns to idle state	Cannot arm (e.g. open zones)
LED flashes red/green	Communication error proximity reader

## Access control with a proximity tag on an external proximity reader

The external proximity reader can be used for simple access control of employees and family members. The proximity reader has an output which is activated for three seconds when a valid tag is presented. This output can be used to activate an electric door opener. For access control the following criteria applies:

Proximity tags programmed with authorization **level 1** will activate the output of the proximity reader, but **only** when the section(s) programmed to this tag are **disarmed**. Use this option only for simple access control to allow users to enter the building or house, but not allowed to arm or disarm the system. Level 1 codes or tags **cannot** arm or disarm sections from the keypad.



Proximity tags programmed with authorization **level 4** will **arm or disarm** the section(s) that are programmed to this tag. Also the output of the proximity reader will be activated to activate the electric door strike.

When a proximity tag with authorization **level 3, 5 or 7** is presented, the system will first check which section(s) are armed. As the same time the system checks if the proximity tag that is presented is authorized for the section(s) that are armed. If the tag is authorized for the section(s) that are armed the output will be activated and access is granted. The user must now present the proximity tags to the LCD/PROX keypad inside to disarm the system.

## Arming and disarming with wireless keyfob transmitters

When the AlphaVision ML has been expanded with the optional wireless receiver module, the system can also be armed and disarmed with wireless keyfob transmitters. Up to 8 wireless keyfob transmitters can be enrolled into the AlphaVision ML's memory. Each keyfob transmitter uses an encrypted code for arming and disarming. The transmitter has 4 buttons each with the following function:



Arm/Disarm	Keyfob transmitter
Arm TOTAL	Press the  on the keyfob
Arm PARTIAL	Press the  on the keyfob
Disarm	Press the  on the keyfob

Your installation company can program which sections are armed with Partial and which with Total arming.

The fourth button on the keyfob transmitter is the so-called AUX button (\*) and is used (depending on programming) for requesting the system status, stopping the exit delay or activating an output.



## USER MENU

The AlphaVision ML control panel has a user menu for programming and modifying user settings. The user menu offers six sub-menus, each with various programming options or functions. The user menu is only accessible with the supervisor code.

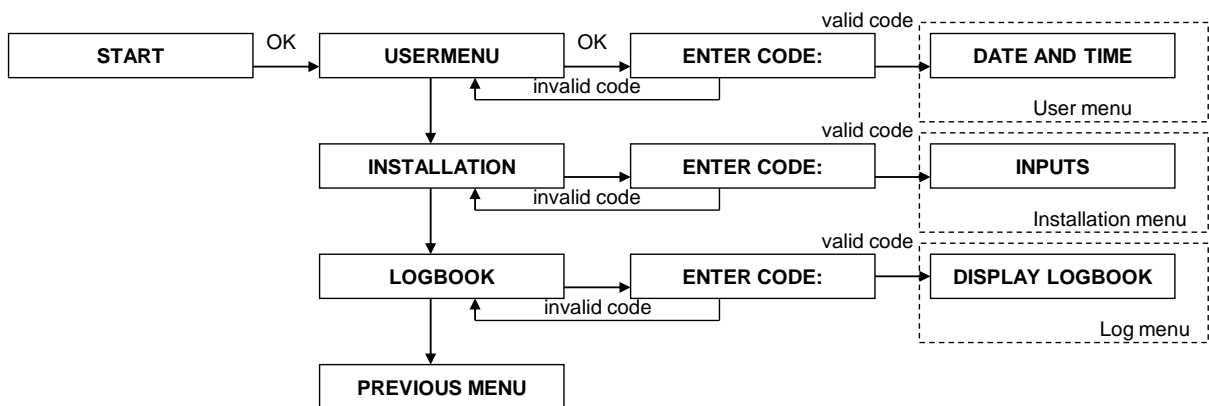
Use the navigator (arrow) keys to scroll through the menu's and options.



The user menu is only accessible with the supervisor code (code number 90, default code = **445566**). From software V2.03 and above also 4-digit codes can be used. Use this code once to enter the user menu and change the supervisor code immediately.

To enter the user menu, press <#/OK>. The display will change to "USER MENU". Press <#/OK> to confirm, the display will now prompt for the supervisor code. Enter the 4 or 6-digit supervisor code and the first submenu "DATE AND TIME" will appear. Use the  and  navigator keys to scroll to the desired submenu and press <#/OK> to enter the submenu's.

The installer menu is only accessible for the installation company, with a separate installer code.

To return to a previous menu, press the  key. This key is also used to move back one position in a programming option (e.g. telephone number).

To leave the user menu, press . The display will change to "Exit menu? <OK>". Press the <#/OK> key to leave the menu.



The user menu offers the following programming options and functions. All options and functions will be explained in the following chapter.

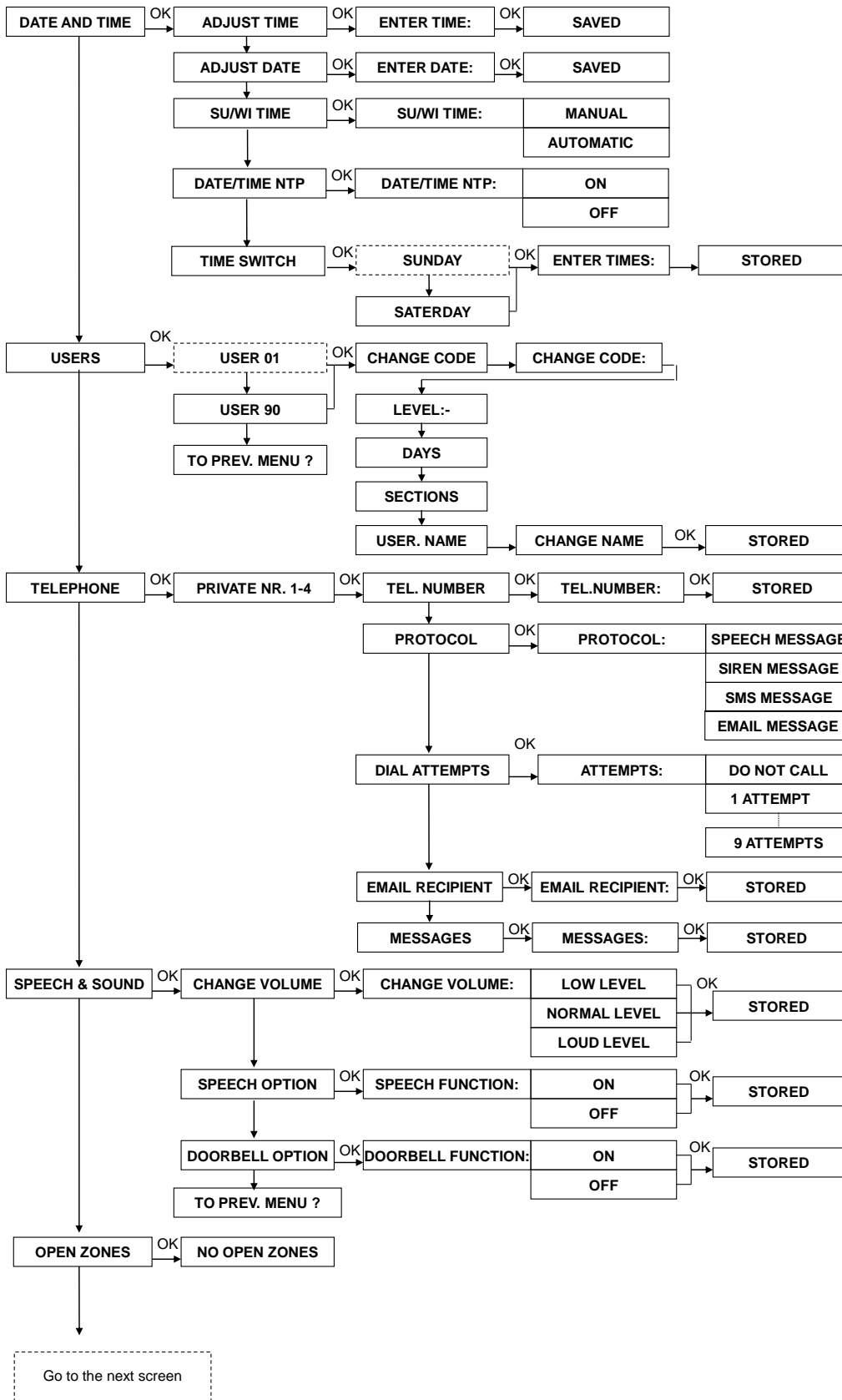

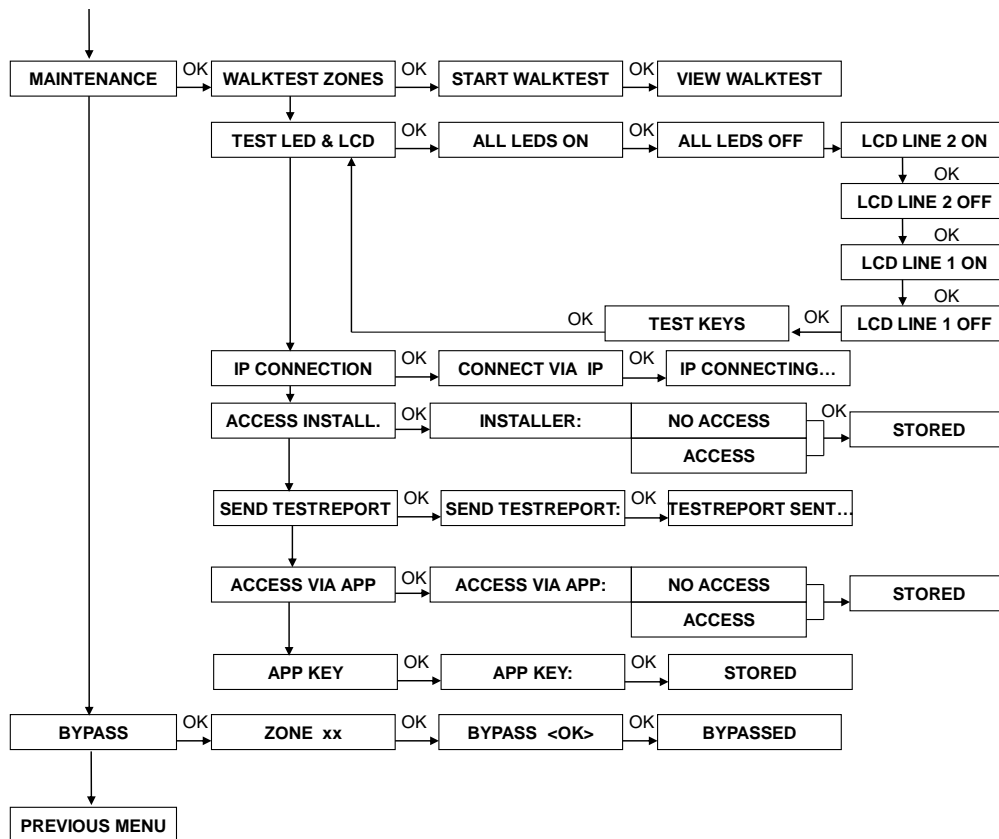

## Date and Time

In the Date and Time menu the following options can be changed:

- Adjust time
- Adjust date

To change the time setting, select the “Adjust Time” option and press <#/OK>. Enter the new time; the time is displayed as **hh:mm** in a 24h notation. Press <#/OK> to confirm the new time.

To change the date, select the “Adjust Date” option and press <#/OK>. Enter the new date; the date is displayed as **dd-mm-yyyy**. Enter the correct date and press <#/OK> to confirm the new date.

From firmware version 3.20 a NTP timeserver option was added in which the time and date is automatically synchronized via an Internet time server. Using the programming option Date / Time NTP can be determined whether the NTP time server function is active or not. The address of the NTP server is available from your internet provider and is often published on their website, ask you installer to enter the correct NTP server address.

## Time switch

From firmware version 3.20 a time switch function has been added to the Alpha Vision ML to automatically arm/disarm the system at pre-programmed times. The time switch function can be programmed in the user menu and is accessible for all users codes level 5 and higher. An arming and disarming time can be programmed for each day of the week including the section(s) that must be armed/disarmed.

In order to alert users that an automatic arming will take place the time switch function is equipped with a pre-arming signal. The pre-arming signal is heard through the loudspeaker ( LS output) and in practice it will usually be heard a few minutes before the actual automatic arming takes place. When programming the switching on and off the alarm time is also programmed.

The time switch programming screen on the keypad is as follows :

**D**00:00 **A**00:00  
**P**00: 00 **S**.... N

**D**00:00 is the disarming time in the morning  
**A**00:00 is the arming time in the evening

**P**00:00 is the pre-arming signal time, often several minutes for the switch (**A**00:00) .  
**S**.... is the section(s) that is armed/disarmed .

An example of an actual time switch programming for all working days ( not include Saturday and Sunday ) is as follows :

**D**08:30 **A**18:30  
**P**18: 25 **S**12.. N

The AlphaVision ML will disarm section 1 and 2 every weekday at 08:30. At 18:25 on every weekday a pre-arming signal will be heard through the speaker, the pre-arming signal will be heard every minute (18:26 , 18:27 , etc. . ) up until 18:30 in which the system will automatically arm section 1 and 2.



### Users

The Users menu is used for creating and modifying user codes. Up to 90 user codes can be programmed, for each code the following settings have to be made:



- code
- authorization level
- valid days
- section(s)
- username

Select the Users menu and press <#/OK>. The display will change to:

USER 01  
01/90 <OK>

Enter the required user number (01 to 90) or use the  and  navigator keys to select the desired user code. Press <#/OK> and the display will change to:

01: 000000 lev 0  
smtwtfs 1234

Press  to jump to the 'code' field. Enter the 6-digit user code and press  to move onto the 'authorization level' field.

▶! *From software version 2.00 and above the AlphaVision ML is protected against the programming of the same usercode twice.*

▶! *If the programming option 4-digit codes is selected (Installer menu / System Options / User Codes) then the last 2 digits of the user code is ignored.*

Each user code needs to be set to an authorization level. The following levels can be selected:

**Level 0** is programmed for inactive codes (e.g. for temporarily blocking a code).

**Level 1** is only used for proximity tags and easy access control via the external proximity reader. Level 1 codes **cannot** be used to **arm or disarm** the system. When a user with a level 1 proximity tag presents his tag to the external proximity reader, the system will first check whether the sections programmed to this tag are disarmed. If disarmed, the output of the proximity reader will be activated. If the section(s) is armed, the output will not be activated.

**Level 2** codes can **only arm** the sections programmed to the user code. The programmed sections are linked together, which means that when sections 1, 2 and 3 are programmed, these three sections will be armed simultaneously. When section 3 was already armed, sections 1 and 2 will also be armed.

**Level 3** codes can **arm and disarm** the programmed sections simultaneously. The programmed sections are linked together, which means that when sections 1, 2 and 3 are programmed, these three sections will be armed and disarmed simultaneously.

**Level 4** codes can **arm and disarm** the programmed sections **without** needing to confirm with the **<\*>** or **<#>** key. Level 4 codes are used for arming and disarming with a proximity tag on an LCD/Proximity keypad or external proximity reader. Several or all sections can be programmed to level 4 codes. The sections are linked and will be armed or disarmed simultaneously. In case one of the sections was already armed, this section will be disarmed first. The next time the proximity tag is presented all sections will be armed.

**Level 5** codes can **arm and disarm** the programmed sections **individually**. The user can select which sections are armed or disarmed. Level 5 codes can also view and confirm information messages on the display.

**Level 6** is not present in the AlphaVision ML.

**Level 7** codes have supervisor rights in the system. Level 7 user codes can arm and disarm like level 5 codes and also have access to the user menu for additional programming options and functions. It is possible to program more than one code as a level 7 code, but it is advisable to limit this to only one code.

By default, user code 90 is the supervisor code, with default code 445566. All codes are 6-digits. From firmware V2.0 and above it is possible to program 4-digit user codes. When 6 consecutive invalid codes are entered, the control panel sends out an alarm message to the monitoring station and locks the keypads for 90 seconds.

Press  to move on to the 'valid days' field.

### Valid days

Each user code can be programmed to be valid only on specific days of the week. This ensures that users do not have access on certain days, such as weekends. The day indications are given with the first letter of the day, starting with Sunday. Use the 1-7 keys to select the desired days. Days not shown are the days of the week that the code cannot be used.



Press  to move on to the 'sections' field.





### Sections

Each user code must be assigned to its valid sections. The AlphaVision ML offers up to eight sections, which can be selected or deselected with keys 1-8.



When all options above have been programmed, press  to continue to the 'user name' field.

## User name

For each user code, a unique user name can be programmed. Each user name can consist of up to 16 characters and is programmed with the  and  navigator keys.

The cursor starts underneath the letter “U”. Use the  and  to select the desired letter and press  to jump to the next letter and  to jump to the previous letter. When the correct user name has been entered, or when no specific user name needs to be programmed, press <#/OK> to save the user code and all its settings.

## Enrolling proximity tags on an LCD/Proximity keypad

Enrolling of proximity tags is similar to programming a new user code. To enroll proximity tags an LCD/Proximity keypad is required. Enter the Users submenu, select the desired code number (01-90) or use the  and  navigator keys and press <#/OK> to jump to the ‘code’ field. Instead of entering a code, present your proximity tag to the integrated proximity reader, this is situated right above microphone hole. The keypad will now automatically generate a unique 6 digit user code.

►! *When using proximity tag’s it is advised to only use 6-digit user codes !*

## Warning against double or conflicting user codes

From firmware V2.0 and higher the system is protected against programming double user codes. If a existing user code is entered into a another user code location the system will not accept the code and the code will be set back to 000000.

## Duress code

The AlphaVision ML control panel also has a duress code function. The duress code function can be used to disarm the system when under distress. The duress code option should only be used when transmitting alarm messages to a monitoring station and only works with regular user codes and not with proximity tags. The installer can activate the duress code function. When activated, a user who is forced to disarm the system can use his regular user code but add 1 to the last digit of his code. If the user code is 987654, the duress code becomes 987655. If the last digit is a 9 replace it with the digit 0. When the system is disarmed with a duress code the control panel will disarm as usual but send out a silent duress alarm to the monitoring station.

►! *When the DURESS code is used, the dialer LED will be deactivated for 15 minutes and the Information Present will not appear. After 15 minutes, or after disarming with a valid user code, the LED’s will function as normal and the Information Present message will reappear.*

## Security against random entering codes

The AlphaVision ML is secured against the random entering of user codes. After 6 consecutive invalid user codes, all keypads are locked out for 90 seconds. After each following invalid code, the keypads will lock again for another 90 seconds, until a valid code is entered. When the control panel is programmed to report to a monitoring station, a special alarm message will be sent.

## Telephone



The main user can program the settings used for reporting to private (fixed or mobile) telephone numbers. Reporting to a private telephone numbers only works when a PSTN or GSM plug-on board is used and does **not** work with IP or GPRS reporting. The following options can be programmed:

- Telephone numbers 1 - 4
- Protocol
- Dial attempts
- Email message (firmware version 3.2 and above)
- Messages ( V3.60 and above). Here you can determine which type of messages are reported to the relevant private telephone or mailed to the relevant email address.

In the **telephone number** programming option, the telephone number of a private (fixed or mobile) phone can be programmed including area code and **without** using any spaces or dashes. Enter the number and press <#/OK> to save.

Besides the standard digits 0 to 9, two special characters can be used:

- w (or W) : wait 2 seconds without dial tone
- (dash) : wait until a dial tone is detected

Use the  and  navigator keys to select the special characters. When a character is selected, use the  to move the cursor to the next position. Always place the 'W' or '-' in **front** of the telephone number. When the correct number is entered, press <#/OK> to save.

►! *By default, the control panel picks up the line and waits for a dial tone. If no dial tone is detected within 10 seconds, the control panel hangs up and tries again.*



After the telephone number has been programmed, the correct protocol for this number needs to be set. Continue to the 'Protocol' option by pressing  and selecting the Protocol option.



The **Protocol** option decides which type of alarm transmission is used with a certain telephone number. The following protocols are available:

- Report spoken messages (only possible when the speech plug-on board is used)
- Report a Siren tone, this generates an alarm tone
- Report a SMS text message, this sends out an SMS text message to a (mobile) telephone
- Send an email message

Only when the AlphaVision ML control panel is equipped with a PSTN or GSM plug-on board, the siren tone or SMS text messages can be sent to a private (mobile) telephone number.

Speech message can only be sent to private (mobile) telephone numbers when the AlphaVision ML is equipped with a speech plug-on board.

Select one of the three options using the  and  keys and press <#/OK> to confirm. After setting the protocol, the number of dial attempts needs to be set. Continue to the 'Dial attempts' option by pressing  and <#/OK>.

In the **dial attempts** programming you decide how many times the AlphaVision ML control panel will try to reach each private telephone number. The number of dial attempts can be programmed from 1-9 or DO NOT CALL. When the option DO NOT CALL is selected, this telephone number will be skipped. The number of dial attempts is programmed using the  and  keys and is saved using the <#/OK> key.



In **Email recipient** an email address can be entered for up to four warning addresses. To send an email as alarm or status message some additional basic settings are needed. Your installer will program this information in the installer menu.



### Speech & Sounds



The Speech & Sounds submenu contains the following options:

- Change volume
- Speech option
- Doorbell option

►! *These options only apply when the AlphaVision ML control panel is equipped with a speech plug-on board including a keypad with integrated speakers, an external speakerphone or an external speaker.*

The **change volume** option controls the volume of the spoken messages heard from the keypad, the external speakerphone or an external speaker. Select the option 'change volume', press <#/OK> and use  and  to select between the options LOW, NORMAL and LOUD. Press <#/OK> to confirm.

The **speech option** allows you to program whether or not the vocal assistance messages are heard from the keypad speakers, the external speakerphone or external speaker. Select 'speech option' and use  and  to select between the options ON and OFF. Press <#/OK> to confirm.

The **doorbell option** controls the doorbell chime. Specific zones can be programmed to sound a doorbell chime through the speakers in the keypad, external speakerphone or separate speaker when the alarm system is disarmed. Select the 'doorbell option' and use  and  to select between the options ON and OFF. Press <#/OK> to confirm.

►! *When the 'speech option' is set to OFF, the doorbell chime is still heard through the speaker. The doorbell function needs to be set separately.*

### Open zones

Open zones can be doors or windows left open, or wired smoke detectors which need to be reset after an alarm. The installer can program, if and which zones can be bypassed. For security reasons it is not wise to be able to bypass certain critical zones, your installer will determine which zones can be bypassed.

When the system cannot be armed because of open zones, the user is alerted during arming. The message 'CAN NOT ARM, OPEN ZONES' is displayed and the alert buzzer is sounded.

When users **are** allowed to bypass open zones, the display will show the first open zone. Any following open zones can be shown by pressing . When the last open zone has been shown, the message "EXIT <\*>, BYPASS <#>" will appear. By pressing the <#/OK> key, the open zones will be automatically bypassed for this arming period and any alarms from these zones will be ignored. Only after disarming and re-arming the system, this zone will function as normal again. By pressing the <\*> key, the arming action is cancelled, allowing the user to close any open zones first (RECOMMENDED).

When users **are allowed** to bypass zones, but this specific zone **cannot** be bypassed due to security reasons, after trying to arm the system first the message 'CAN NOT ARM, OPEN ZONES' is displayed. After pressing the <#/OK> button the message 'BYPASS NOT ALLOWED' will appear. After a few seconds the system will return to idle state. Close the open zone(s) and try to arm the system again.

When users **are not allowed** to bypass zones, the display will first display the message 'CAN NOT ARM, OPEN ZONES' and then automatically display the first open zone. Use the  key to display any other open zones. After reading all open zones press the <\*> button to leave the open zone menu. All open zones will need to be closed first before the system can be armed.

### Maintenance

The maintenance menu offers several functions used for periodic checking and servicing of the system. The following options are available:

- Walktest zones
- View zones
- Test LCD display & LED's
- Remote Service
- Installer access
- Acces via app
- App key

## Walktest zones

It is highly recommended that the supervisor regularly performs a so-called walktest to ensure that all detection components function correctly. Select the 'Walktest zones' option and press <#/OK> to start the test. The display will show "Start Walktest, ...busy..." When performing a walktest, all zones need to be activated one by one. Each time a detector is triggered, the keypad will sound an alert beep and the specific zone information is shown on the display including its zone name and actual RF reception strength (only applicable to wireless zones, e.g. RF=108).

For hardwired components the displayed reception strength has no meaning and will always be shown as RF=099. When the AlphaVision ML control panel is equipped with a wireless receiver unit, the actual reception strength is displayed for wireless detectors.

When wireless motion detectors (also known as PIR detectors or sensors) are used, keep in mind that they contain a sleep function: to save battery power the wireless motion detectors goes to sleep after each detection. If no motion is detected during the following 2 minute period, the detector will wake up. When performing the walktest, make sure that at least two minutes has passed since the last detection, before entering that specific room.

Each time a detector (zone) is triggered, the internal buzzer of the keypad will sound **three** times to indicate a successful detection. When the control panel is equipped with the speech plug-on board and a speaker, the speech message 'Zone open' including '<Zone Name>' can be heard as well.

When all zones have been triggered, use the **View zones** option by pressing the <#/OK> key to scroll through the list of all activated zones. Make sure that all detectors (zones) which are present in your installation have been triggered and are shown in the list. To exit the walktest function, press the  button twice.

The control panel can remain in walktest mode for up to 30 minutes; after which the control panel returns back automatically to idle state. This prevents the walktest function to be active unintentionally and prevents the control panel from not functioning when armed.

Not all 24-hour zones can be activated. A smoke detector for instance can only be tested with special test smoke and a glassbreak detector only with a special tester. The installation company will (can) test these detectors during the annual maintenance.

▶! *The RF reception strength of each wireless detectors needs to be 20 at least. When the reception strength drops below 20, the signal strength is no longer guaranteed and the necessary measures needs to be taken to improve the reception. Contact the installation company for this.*

▶! *When the walktest mode is exited, the reset output will be activated to reset wired smoke detectors.*

## Test LED & LCD

The **Test LED & LCD** function is used to check the correct functioning of all status LED's, LCD display and keys on each keypad. Select the 'Test LED & LCD' function and the display will show the first option 'ALL LED'S ON'. Ensure that all LED's of the keypad are illuminated, including the background LED's of the display and the silicone keys. Press the <#/OK> button to select the next option, the steps are self explanatory and will be shown on the display.

## IP connection

The supervisor has the ability to establish a IP connection between the AlphaVision ML control panel and the laptop / computer of the installer where the Alpha Tool software is installed. In this remote access can be done without the need for changing firewall settings and port forwarding in the router of the end-user.

## Remote Service

The installation company can access the control panel remotely for servicing. He can make changes in the programming and/or consult the historical log. When the installation company does not know the supervisor code, he cannot arm/disarm or edit/create user codes.



The installation company might ask you to initiate the Remote Service connection. This starts up an IP connection between the AlphaVision ML control panel and the service computer of the installation company. The installation company will guide you through the possible options: Remote Service, Port Settings, IP address settings.

►! *Even though the Remote Service function does not allow the installation company to arm or disarm the system or create or edit user codes, the Remote Service function does allow changing of system settings. Take appropriate measures and make clear agreements with your installation company to prevent unauthorized access.*



### **Installer access**

The supervisor can use this option to determine whether the installer has direct access to the installer menu or access is only possible via the user menu.



### **Transmit testmessage**

The supervisor has the option to manually force the panel to send a testmessage to the monitoring station. Your installer may request you to perform this option.

### **Access via App**



From software V2.03 a mobile application (APP) is available for the Alpha Vision ML. The supervisor must indicate whether the APP has permission to connect to the Alpha Vision ML. Use the  and  navigator keys to choose between the options: ACCESS or NO ACCESS. Make a selection and press <#/OK> to confirm the selection.

### **App key**

A part of the mobile application (APP) is a unique key. This key needs to be entered both in the AlphaVision ML and the mobile application (APP). The key is checked when establishing a connection. When entering the APP key the  and  navigator keys can be used to programmed the desired letters, numbers or special symbols. Press the  key to jump to the next position. If the APP key only consists of numbers these may be entered using the numerical keys on the keypad. Press the <#/OK> button to store the APP key.

### **Bypassing zones**

From firmware V3.2 and above it is possible to bypass (block) zones prior to arming the system. This functionality can be very useful if a zone is faulty or a continuous false alarm occurs preventing the system from being armed. By bypassing (temporarily blocking) the zone the alarm system can be armed, the bypassed zone is not active and cannot generate an alarm. Bypassing a zone applies only to one arming period, once the system is disarmed the bypassing is automatically erased. If the zones needs to be bypassed again, a bypass function must be performed again before arming.

To bypass a zone in advance select the "Bypass" option in the user menu. Now enter the desired zone number (2-digit) or use the a the  and  keys to scroll to the desired zone number. Now press the <#/OK> key to confirm the bypass function.

### **Historic Log**

The supervisor can also access the historic log. The historic log shows the last 250 event. The top line in the display shows the event type and the bottom line shows the date and time. Use the navigator keys to scroll through the events.

## REPORTING TO PRIVATE (MOBILE) TELEPHONE

If the AlphaVision ML is equipped with an optional PSTN (analogue) or GSM plug-on board and the control panel reports alarms to private telephones, the AlphaVision ML will call to the programmed telephone number to report an alarm. The control panel can report using a Siren tone (fixed line or mobile phone) or SMS text messages (mobile phone only)

- ! *From firmware V2.0 and above the dialing sequence to private (mobile) phone numbers will be terminated immediately after the system has been disarmed. This to prevent that friends and family are called due to a false alarm or user error.*

When using the optional speech plug-on board, the AlphaVision ML can also report pre-recorded speech messages (fixed line or mobile phone).

### Acceptance mode

When reporting to a private telephone number, the receiving party needs to confirm the alarm message by pressing a numerical key on his/her phone. This confirmation code is required to inform the AlphaVision ML control panel that the message is received and understood by the receiving party. When the control panel reports to more than one telephone number, the installation company can program whether 'SINGLE' or 'ALL' telephone numbers need to confirm the alarm message.

The receiving party can confirm the alarm message by pressing <9> on his/her (mobile) phone. When 'SINGLE' is programmed, the control panel will stop dialing and regard the alarm reporting as finished. When 'ALL' is programmed, all programmed telephone numbers need to confirm the alarm message by pressing <9> on their (mobile) telephone.

When the Siren tone message protocol is used, the dialed party will hear an alarm tone when the phone is answered. The Tone message is confirmed by pressing <9> on the (mobile) telephone.

When the SMS text message protocol is used, the SMS server will automatically accept and confirm the alarm message. When using SMS text message reporting to more than one telephone number it is important to only use 'ALL' acceptance.

When the Speech message protocol is used, more options are available:

### Speech/Listen-in option

The AlphaVision ML control panel can also be expanded with a speech/listen-in option. For this option the control panel must be equipped with a speech plug-on board including a keypad with integrated speaker and microphone, a speakerphone or a separate speaker and microphone. The speaker and microphone allow the called party to start a 2-way conversation between themselves and the local user of the AlphaVision ML or to listen-in to the premises. The called party can switch between Speak out <2> or Listen-in <1>. Consult the installation company if this option is desired.

When using the speech plug-on board and reporting with the Speech message protocol, the called party will first hear the house ID (if recorded), followed by the speech messages indicating which event occurred in which zone. Finally, the system status is reported. Besides confirming the alarm message with key <9>, a number of other options are also possible:

- Key 4: Partial arming
- Key 5: Request system status
- Key 6: Total arming
- Key 7: Activate output (latch or pulse)
- Key 8: Deactivate output (latch) or activate output (pulse)
- Key 9: Confirm alarm message and disconnect
- Key 0: Disarm control panel

The speech plug-on board also offers the opportunity to remotely arm and disarm the system or activate/deactivate an output. Make sure any of the other options are executed **before** pressing <9>!

►! *Remotely arming (key 4 and 6) - and disarming (key 0) has a danger. Each private phone number being called can perform this option regardless of the actual authorization of the called party !*

When the 'Activate Output' function is executed, key <7> will activate the programmed output and key <8> will deactivate the output. The control panel can also activate the output for a short time (1 second, single pulse). If this is programmed, both key <7> as <8> will activate the output for 1 second. Consult the installation company for more information.

When the AlphaVision ML control panel is equipped with **both** a speech plug-on board as well as a keypad with integrated speaker and microphone, a speakerphone or separate speaker and microphone, the called party can activate a semi-duplex speech/listen-in session. Use the following keys on the telephone for this function:

- Key 1: Listen-in
- Key 2: Speak

### **Inactivity**

The AlphaVision ML can be programmed to contain an 'inactivity' function with certain zones. The inactivity function sends out an alarm to a monitoring station or private telephone number when NO activity (the detector did not sense any motion) was registered for the programmed zones during a certain period of time. This function can be very handy for elderly or physically challenged people. The inactivity functions is only active when the section(s) that the specific inactivity zones are linked to, are disarmed.

### **Remote control of the AlphaVision ML**

When the speech plug-on board is used, the AlphaVision ML control panel can be remotely controlled by using a (mobile) telephone (this option has to be enabled in the programming). All functions as described in the 'Reporting to private telephone' chapter can be executed from a telephone. This option can be useful when the user forgot to arm the system or wishes to remotely disarm it.

When the AlphaVision ML control panel is equipped with **both** a speech plug-on board as well as a keypad with integrated speaker and microphone, a speakerphone or separate speaker and microphone, the called party can also activate a semi-duplex speech/listen-in session.

For remote control or remote service the installation company will program the AlphaVision ML control panel to accept incoming calls. There are two options: single ring-in or double ring-in.

#### **Single ring-in**

Dial the telephone number of the AlphaVision ML control panel and allow the line to ring 4 times. The AlphaVision ML will automatically pick up the line and prompt for a valid 6-digit user code. Enter a valid user code. When accepted, the AlphaVision ML will play the house ID (if recorded) to confirm you are connected and are in the main menu. For further options, see chapter 'Reporting to private telephone'.

#### **Double ring-in**

Dial the telephone number of the AlphaVision ML control panel and allow the line to ring 4 times. Hang up the line and wait for at least 20 seconds. Redial the AlphaVision ML, the control panel will automatically pick up the line after 4 rings and establish the connection. The procedure is similar to Single call.

## **IP REPORTING**

The AlphaVision ML has an on-board IP dialer for reporting alarm and trouble messages to a monitoring station, fast and **without** additional dial costs.

Nowadays many internet providers offer all-IP solutions, in which internet, digital television, Voice-over-IP (VoIP) telephone and PIN-over-IP are combined. When migrating to all-IP services usually the existing analogue (PSTN) or ISDN line are often cancelled. Alarm reporting to a monitoring station using a PSTN dialer over a VoIP connection causes troubles in many cases and is not advised. By using the on-board IP dialer, alarm and trouble messages are sent to the monitoring station over the existing broadband internet connection in a safe, secure and fast way. Consult your installation company for more information about IP reporting.

The on-board IP dialer is **not** suitable for reporting to private (mobile) telephones.

## **PSTN PLUG-ON OPTION**

For alarm reporting to a private telephone number, or when only a analogue (PSTN) telephone line is available, the AlphaVision ML can be expanded with the PSTN plug-on board. The PSTN plug-on board is placed directly on the AlphaVision ML main board and is connected to the PSTN line, or to the analogue telephone output of the cable/DSL modem. When connected to an analogue output of the modem, the control panel with PSTN plug-on board can only report to private telephones. When connected to a regular analogue PSTN line the control panel with PSTN plug-on board can report to a monitoring station and/or to private telephones.

For more information about alarm reporting over a PSTN line, consult the installation company.

## **GSM PLUG-ON OPTION**

When no fixed telephone line is in the premises and the AlphaVision ML needs to report to a monitoring station or private (mobile) telephone, the control panel can be expanded with a GSM/GPRS plug-on board. The GSM plug-on board uses a SIM card with subscription and can report messages over the GSM network to a monitoring station and/or to private (mobile) telephones. For more information about GSM reporting, consult the installation company.

## **GPRS PLUG-ON OPTION**

The GSM/GPRS plug-on board can also report alarm messages over the GPRS network. GPRS data reporting is only possible when reporting to a monitoring station and can be used as a primary or backup dialer. The GSM/GPRS plug-on board needs to be equipped with a SIM card capable for GPRS data communication. For more information about GPRS reporting, consult the installation company.

## **INTEGRATION WITH KNX HOME AUTOMATION (V3.50 AND HIGHER)**

The AlphaVision ML can be integrated to a KNX home automation bus to enable/disable lighting and other KNX devices during a particular event in the AlphaVision ML. For more information about KNX integration please contact your installer.

**APPENDIX A: DETECTOR DEPLOYMENT (ASK INSTALLATION COMPANY TO COMPLETE)**

Zone Nr.	Zone type	Zone input type	Detector location or transmitter assignment ( for social alarm transmitters)	Doorbell (Yes/No)	Bypass (J Yes/No)	Section (1, 2, 3, 4)	Inactivity (X = Yes)
1							
2							
3							
4							
5							
6							
7							
8							
9							
10							
11							
12							
13							
14							
15							
16							
17							
18							
19							
20							
21							
22							
23							
24							
25							
26							
27							
28							
29							
30							
31							
32							
33							
34							
35							
36							
37							
38							
39							
40							
41							
42							
43							
44							

**Zone types:**

- |                     |                          |
|---------------------|--------------------------|
| 1 = Direct          | 10 = Tamper              |
| 2 = Delayed 1 t/m 4 | 11 = Follower            |
| 3 = Delayed 5       | 12 = Follower delayed    |
| 4 = Emergency door  | 13 = Technical alarm     |
| 5 = 24 hour silent  | 14 = Gas                 |
| 6 = 24 hour loud    | 15 = Water               |
| 7 = Fire            | 16 = Temperature         |
| 8 = Social alarm    | 17 = Direct dialer input |
| 9 = Hold-up         | 18 = Keyswitch           |

**Zone locations:** The installation company will write down the locations for each detector here.

**APPENDIX B: KEYFOB TRANSMITTER ASSIGNMENT**

Transmitter			AUX button		
Nr.	Type	User name	Status	Quick arming	Activate output
1					
2					
3					
4					
5					
6					
7					
8					

**APPENDIX C: SOCIAL ALARM TRANSMITTER**

Tx #	Transmitter type	Zone nr.	Zone type	User name
1				
2				
3				
4				
5				
6				
7				
8				
9				
10				

## APPENDIX D: PROGRAMMED PRIVATE TELEPHONE NUMBERS

Tel #	Telephone number	Protocol	Name
1			
2			
3			
4			



### WEEE-declaration

This Alpatronics product is manufactured with the most modern technology and consists of high quality components. Most of the components used can be recycled. The symbol means that this product should be recycled separately and not put in the normal waste bin together with normal household waste.

This product can be handed over to your local city council disposal point, shop or supplier.

© ALPHATRONICS BV – 2014

